

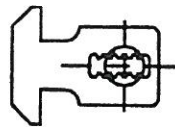

GÂCHE  
SELON PROFIL  
VOIR PAGE 4



PENE  
SELON PROFIL  
VOIR PAGE 3



VERROU

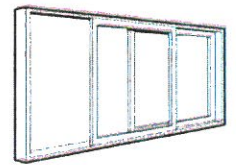

BOUTON TIRAGE  
INTERIEUR  
G 19 700

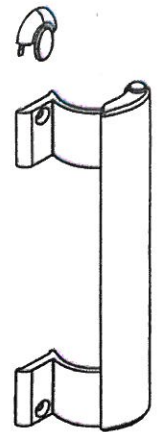

EURIS

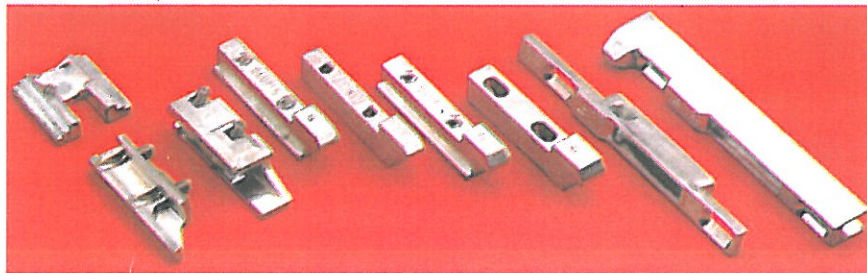

REF

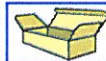

### VERROU MANUEL M 1 à clipper - G 46 666

BLANC	33.5	20
NOIR	33.7	20
<b>ANTI FAUSSE MANOEUVRE "selon profil".</b> <i>Empêche la manoeuvre du pène, porte en position ouverte afin d'éviter la casse.</i>	33.40	20



### VERROU AUTOMATIQUE Euris MA - G 46 669

Pratique pour les fenêtres

Blanc	33.8	20
Noir	33.28	20

### TIRAGE INTERIEUR

Avec Riv clé à sertir

Bouton avec riv clé à sertir - BLANC	33.9	20
Poignée OTHEA - 200 mm - ARGENT	55.1	1
Poignée OTHEA -200 mm - BLANC	55.8	1

Kit complet - serrure intérieure verrous + pène		
---	--	--



Skinpack  
Quart de Tour

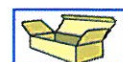

33.90

1

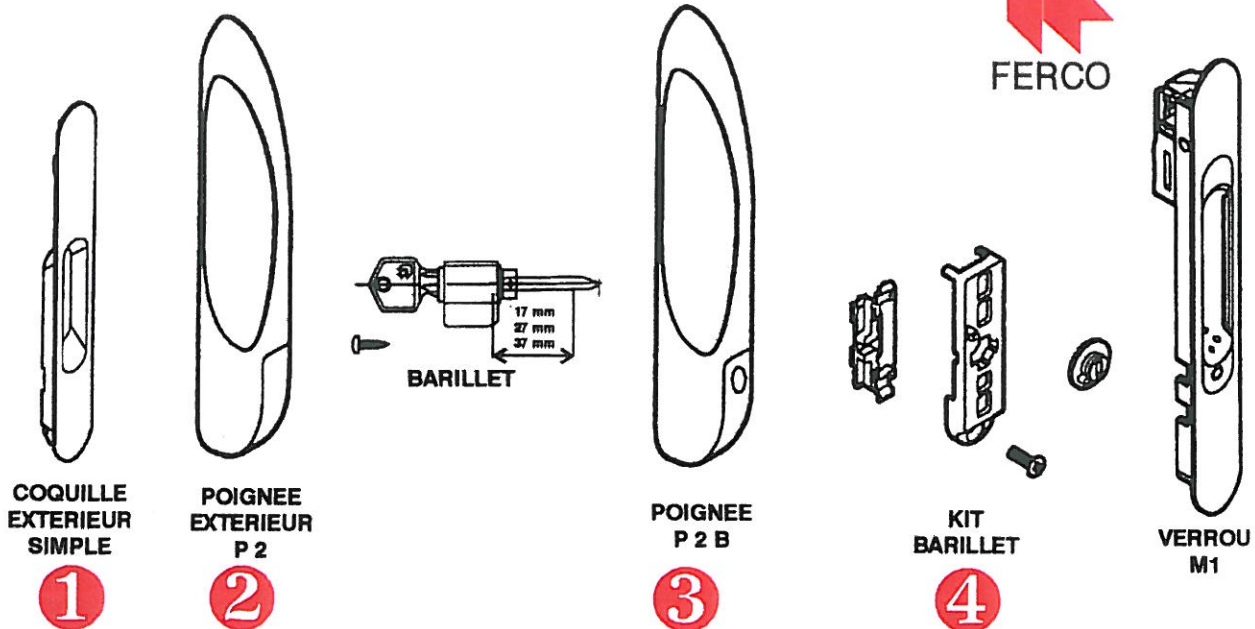
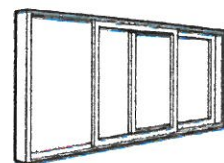

COQUILLE EXTERIEUR SIMPLE

POIGNEE EXTERIEUR P 2

POIGNEE P 2 B

KIT BARILLET

VERROU M1

1

2

3

4

REF

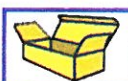

TIRAGE SIMPLE

}	1	<b>COQUILLE MOULEE EXTERIEUR FIXE -</b>	<b>G 19941</b>
		BLANC	33.15    20
		NOIR	33.16    20

}	2	<b>POIGNEE DE TIRAGE EXTERIEUR SIMPLE</b>	<b>G 46 630</b>
		P 2 SIMPLE BLANC	33.11    20

TIRAGE + VERROUILLAGE

}	3	<b>POIGNEE DE TIRAGE EXTERIEURE POUR BARILLET -</b>	<b>G 19 694</b>
		P 2 B BLANC	33.13    20
		P 2 B NOIR	33.14    20

}	4	<b>BARILLET</b>	
		KIT BARILLET	33.17    20
		BARILLET + VIS 17 mm	33.18    10
		BARILLET + VIS 27 mm	33.20    10
		BARILLET + VIS 37 mm	33.19    10

Kit complet - serrure à clé ext.  
verrous + pène + poignée Ext. +  
barillet + kit barillet

Skinpack  
Quart de Tour

33.91



1

# COULISSANT ALUMINIUM PENE CRANTE POUR COULISSANTS

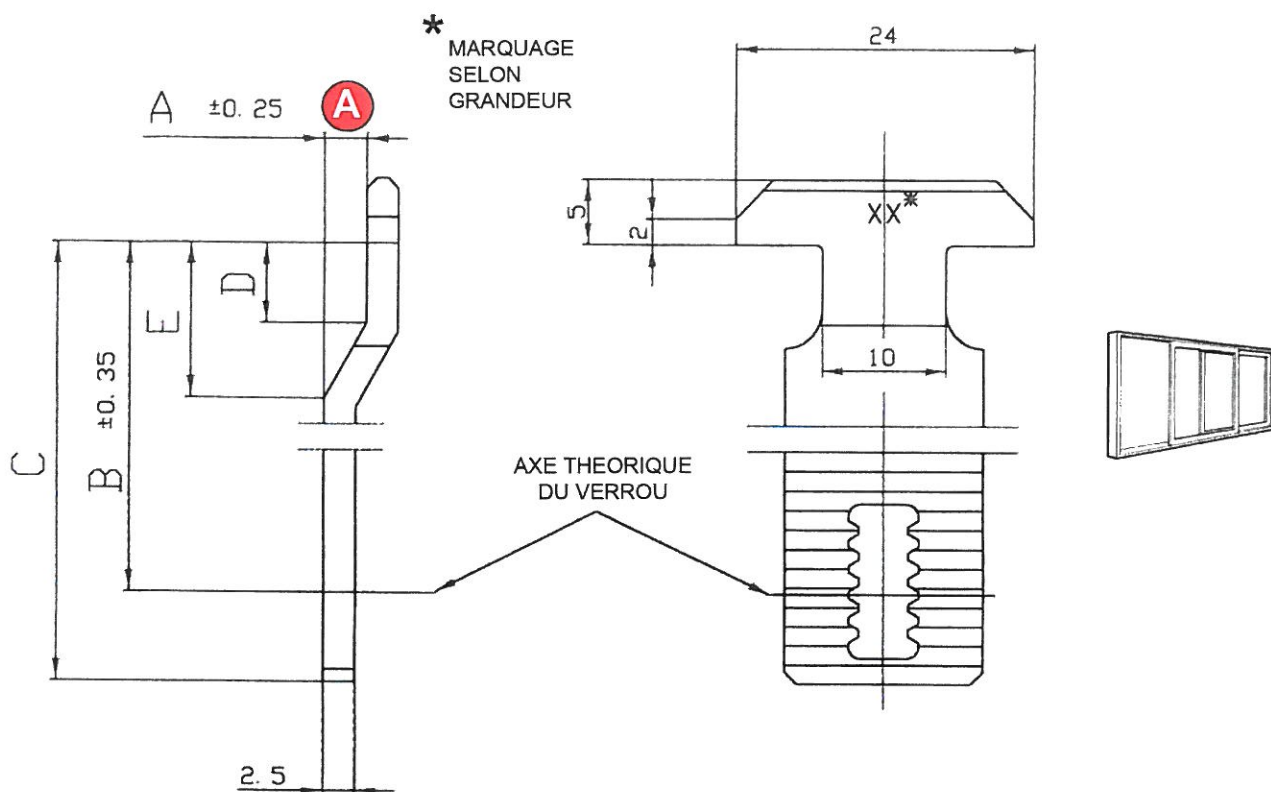

Gamme	Grandeur <b>A</b>	B	C	D	E	Code Ferco	Ref		
Sépalumick	GR 1	0	22	29	0	0	E-19542-01-0-8	<b>33.22</b>	1
Installux-ps-furio-alutec	GR 2	2	23.5	33.5	7	10	E-19542-02-0-8	<b>33.23</b>	1
ps furio-périmétal	GR 3	1	25.2	32.5	9.5	1.4	E-19542-03-0-8	<b>33.21</b>	1
raeyners-aluval-intexalu	GR 4	0	17	24	0	0	E-19542-04-0-8	<b>33.24</b>	1
Alutechnie-bourbon-vepral	GR 5	2.5	18.5	25.5	+/- 2	+/- 5	E-19542-05-0-8	<b>33.25</b>	1
	GR 6	1.5	19	26	2.7	6.5	E-19542-06-0-8	<b>33.53</b>	1

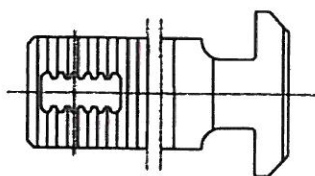
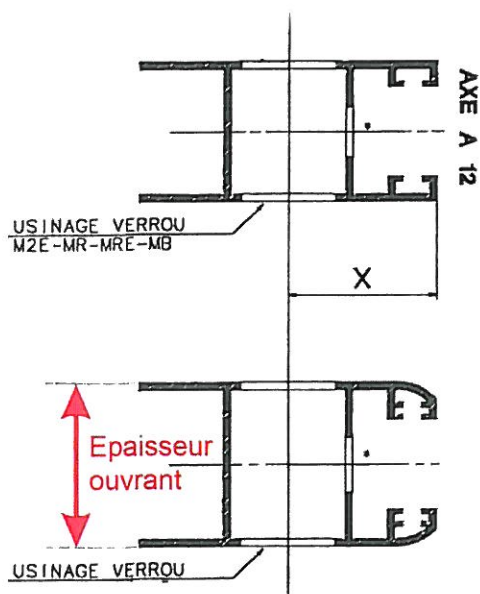

Quand on ne connaît pas la marque du profilé : Mesurer l'épaisseur de l'ouvrant, le pêne doit être à l'axe

$$\text{le coude } \mathbf{A} = \frac{\text{Epaisseur de l'ouvrant}}{\text{Axe fixe du verrou}} \times 2$$

Axe fixe du verrou  
( Savio = 12 mm  
Ferco-Euris = 15 mm )

# B 8.1 COULISSANT ALUMINIUM

PAGE 4

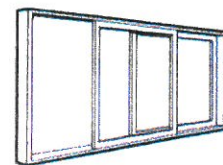

## GACHE POUR COULISSANT

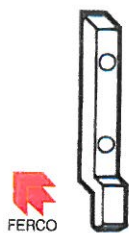

FERCO

Réf IN	33.33
Code Ferco	E-12899-00-0-1
Gamme	Perfival



FERCO

Réf IN	33.32
Code FERCO	G-12914-00-0-1
Gamme	Aluval - alutechnie



FERCO

Réf IN	33.30
Code FERCO	G-12898-00-0-1
Gamme	Intexalu bourbon vepral

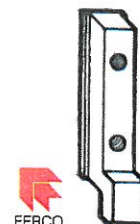

FERCO

Gâche avec clip en inox

Réf IN	33.31
Code FERCO	G-12945-00-0-1
Gamme	Idem Ref : 33.30 modèle avec plaque inox pour fenêtre équipée de verrous automatiques



Réf IN	33.74
Code Savio	2070;879
Gamme	212 Massica ps et furio

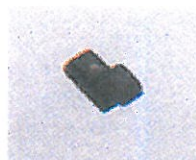

2070.876

Réf IN	33.75
Code Savio	2070.8796
Gamme	



FERCO

Gâche à visser  
E-12901-00-0-1



FERCO

Gâche à visser  
E-20568-00-0-1



FERCO

Gâche à visser  
E-15801-00-0-1



FERCO

Gâche à visser  
G-14765-00-0-1



FERCO

Gâche à visser  
G-11337-00-0-1

Skinpack  
Quart de Tour



Kit 2 gâches ( Ref : 33.30 ) + 2 pènes ( ref : 33.25 )

33.89

1

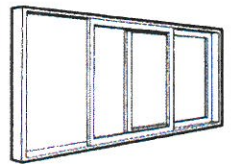

REF

**POIGNEE - VERROU APPLIQUE  
"SORGHO"**

33.42

Semi automatique Ht 92 mm - Aluminium blanc - bouchon noir  
Livré avec gâche N° 6153 - Ht 70 mm - Ea 50 mm

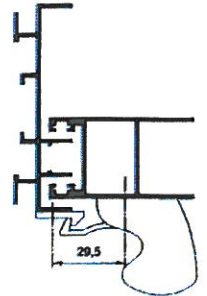
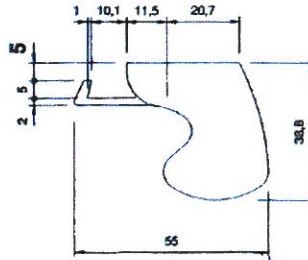

BOITIER ET TRINGLE EN MATERIAUX DE SYNTHESE,  
CROCHETS INOX.  
SELON LES PROFILS, IL Y A DES ADAPTATIONS  
SPECIALES... NOUS CONSULTER.

**KIT INTERIEUR \***  
comprenant :

33.57

1 Verrou euris blanc ref. 33.5  
6 Pènes fournis ( choix selon profil )  
2 Boitiers SOYA n° 5123 ( avec déport D1 - 12,9 )  
1 Tringle plate non usinée 2 ml N°5127

**KIT EXTERIEUR A CLE \***  
comprenant :

33.58

idem Kit intérieur  
+  
1 Poignée extérieur blanche ref. 33.13  
1 Kit barillet ref. 33.17  
1 Barillet 27 mm ref. 33.20

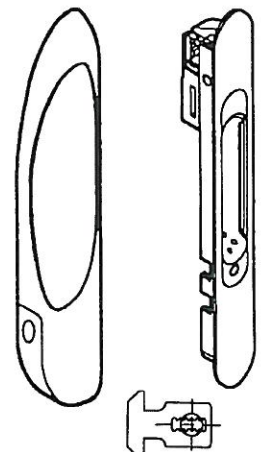
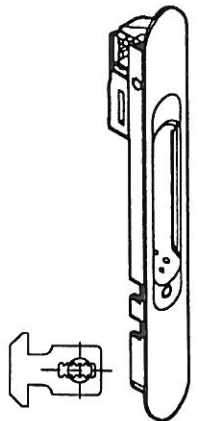
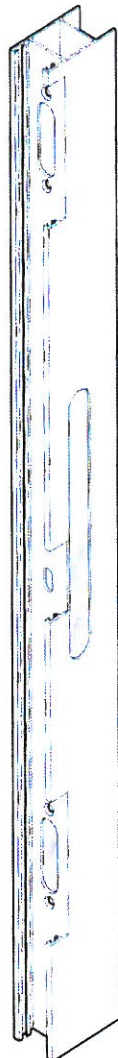

\* Arrêt après épuisement du stock

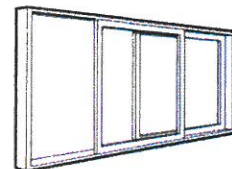

REF



Skinpack  
Quart de tour

**VERROU DE CONDAMNATION ALUMINIUM A TIRETTE**

Fixation latérale pène 19.5 mm - Y compris bouchon

Blanc RAL 9010 - HP = 9,5 mm	33.34	25	33.34 C
Noir RAL 9005 - HP = 9,5 mm	33.41	25	
A clé Blanc - HP = 14,00 mm	33.61	25	33.61 C

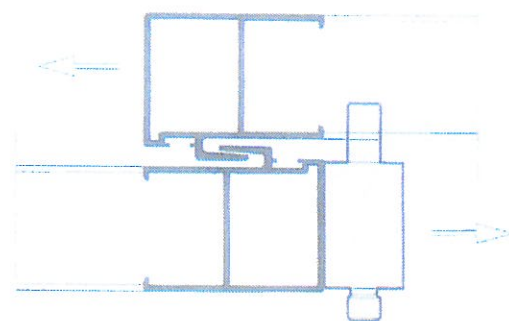
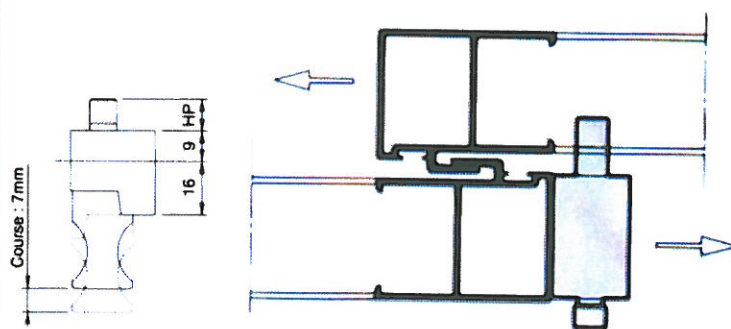
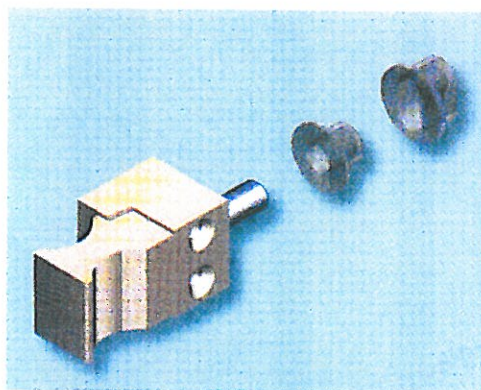

**SUR COMMANDE : Butée limiteur d'ouverture  
sans câble RAL 9010**

Net TTC: 49,00 ☐

