

COULISSEAU

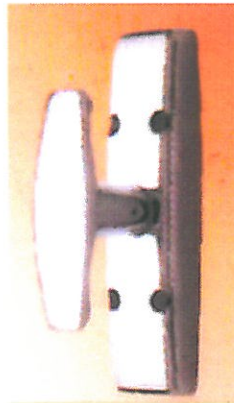

Vrac

REF



REF

## CREMONE CHROMEE

Chromée - Avec accessoires sans tringle.

A bouton	621.3	10	621.3 C
A anneau	621.4	10	621.4 C
TRINGLE	A. Zing. - 1.30 ml	621.6	20
	A. Zing. - 2.00 ml	621.5	20
	A. Zing. - 2.50 ml	621.19	20
	Chromée - 2.00 ml	621.27	20

### Accessoires séparés

Sachet gâche chromée	621.21	1
----------------------	--------	---

## CREMONE BLANCHE

Blanc Epoxy - Avec accessoires sans tringle.

A bouton	621.7	11	621.7 C
Tringle blanche 1.60 m	621.11	10	
Vis blanches 4 x 35 Pan head	27.3	Bte de 1000	
Sachet de 16 vis	27.3 S	1	

## CREMONE SATINEE "Façon INOX"

A bouton	621.25	10
Tringle - 1.15 m	621.26	20

## CREMONE RUSTIQUE - Entraxe pions : 105 mm

Fonte <b>noire</b> sans tringle	621.1	20	621.1 C
Tringle noire 1,30 m - 16 x 5	621.23	20	
Tringle noire 2,50 m - 16 x 5	621.24	20	
Acier <b>vieux laiton</b> sans tringle	621.2	1	621.2 C
Jeu de 2 tringles <b>vieux laiton</b> de 1,15 ml	621.28	1	



**Nouveau**  
"mise en oeuvre"  
très facile

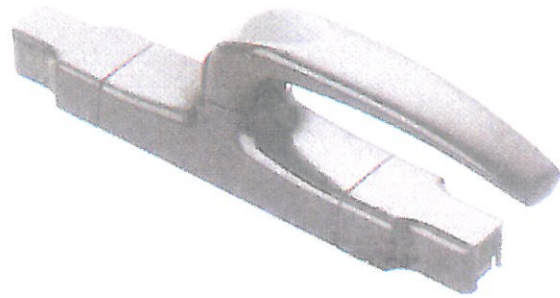
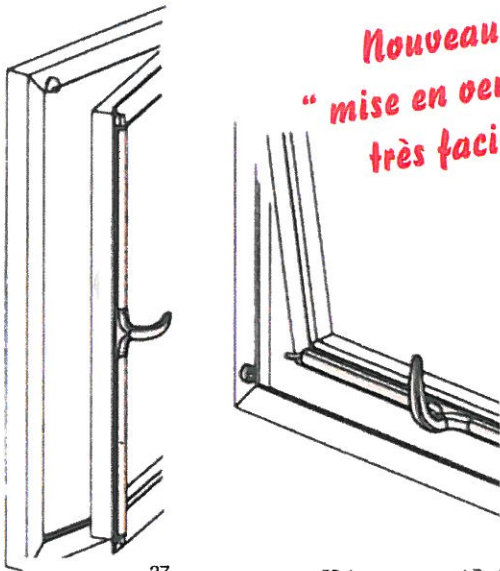

## AV SAVIO Applicadue

Vrac

REF

Conditionné

REF



### CREMONE TOURNANTE APPLIQUE

Course 19 mm par embout inox sertis dans le tube carré acier thermolaqué - 4 vis tête cylindrique plate 3,9 x 13 mm  
Modèle très rigide

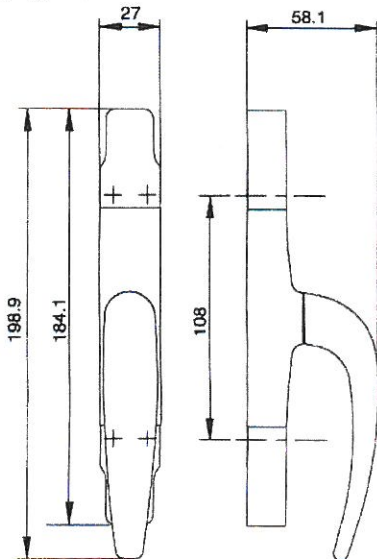

Blanche RAL 9010

621.8

Promo net  
9,90 €

20

621.8 S

Promo net  
12,00 €

Noire RAL 9005

621.9

Promo net  
9,90 €

20

621.9 S

Promo net  
12,00 €

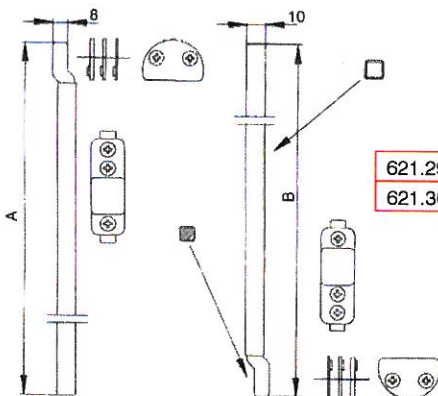

	A	B
621.29	950	1280
621.30	1280	1280
	1280	2000

### KIT DE TRINGLE VERTICALE *Promo net 4,99 €*

Acier thermo-laqué avec sortie de tringle pré-assemblée  
2 coulisseaux - 2 gâches - 2 cales nylon 1 mm - 1.5 mm  
2 mm - 10 vis tête cylindrique plate 3,9 x 13.  
Par positionnement des tubes à embout soudé on est compatible à fleur et à recouvrement

Vrac

Blanc

Noir

621.29

621.31

Promo net  
11,90 €

Conditionné à l'unité

Blanc

Noir

621.29 S

621.31 S

Promo net  
13,90 €

621.30

621.32

Promo net  
12,90 €

621.30 S

621.32 S

Promo net  
14,90 €

1900 mm

10

2500 mm

10

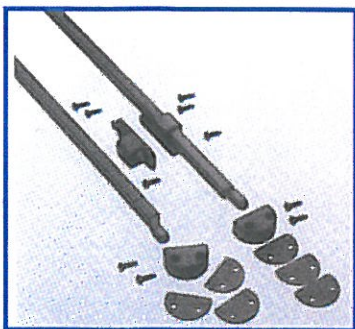

### GÂCHE POUR SOL LAITON DIAM. 10



621.33

100

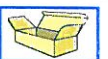

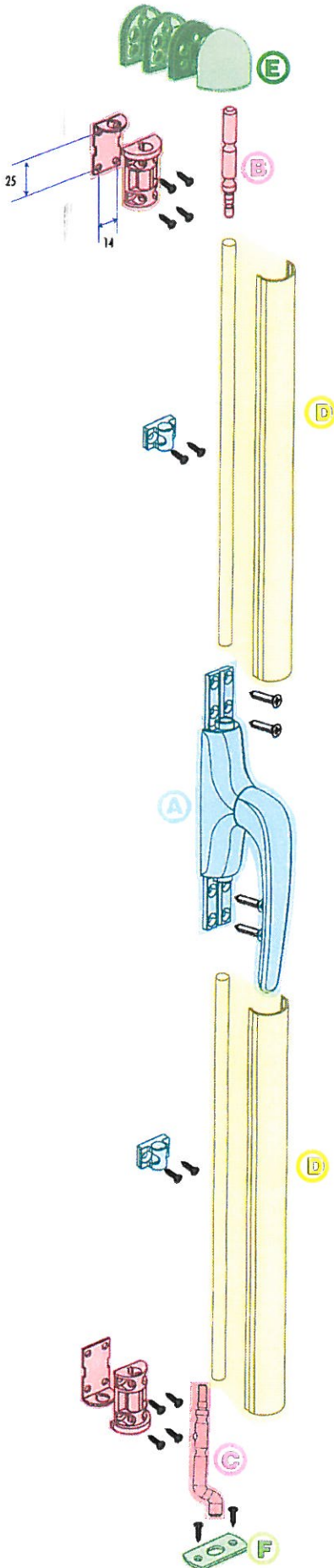

Crémone pour volet battant adaptable sur tous types de volet battant bois, PVC ou aluminium, ce système de fermeture permet s'assurer la fermeture de vantaux avec battue par 2 points.

Esthétique, adaptée dimensionnellement et techniquement pour répondre le plus largement à tous les cas de pose, cette crémone offre la possibilité d'être verouillable.

		Vrac		
		REF		
<b>A</b>	<b>CREMONE ALU BLANC RAL 9010</b> 1 Crémone, 2 coulisseaux.	621.10	1	<b>Promo net 11,50 €</b>
<b>B</b>	<b>Embout Droit</b> <b>INOX</b>	621.34	1	<b>Promo net 1,20 €</b>
<b>C</b>	<b>Coudé</b> <b>INOX</b>	621.35	1	<b>Promo net 2,90 €</b>
<b>D</b>	<b>Tringle + Cache RAL 9010</b>			
	1.00 m	621.13	1	<b>Promo net 4,90 €</b>
	1.80 m	621.14	1	<b>Promo net 6,90 €</b>
<b>E</b>	<b>Gâche applique seule</b>	621.22	1	<b>Promo net 2,90 €</b>
<b>F</b>	<b>Gâche de seuil</b>	621.36	1	<b>Promo net 1,90 €</b>

# B 6.1 CREMONES SPECIALES

PAGE 4

Vrac

REF

U.Emb

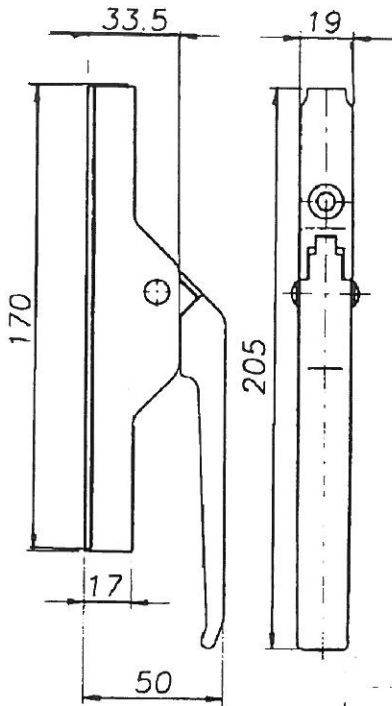

## CREMONE A LEVIER FORTE

Skinpack  
Quart de tour

Zamac noir + accessoires	621.15	1	621.15C
Tringle carré de 10 zinguée - 2 ml	621.16	1	

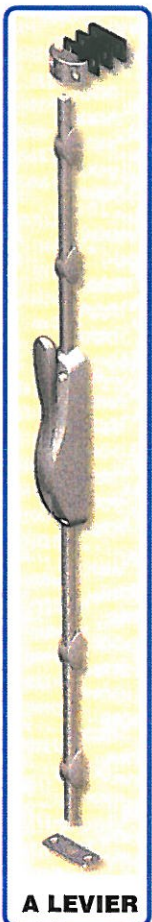
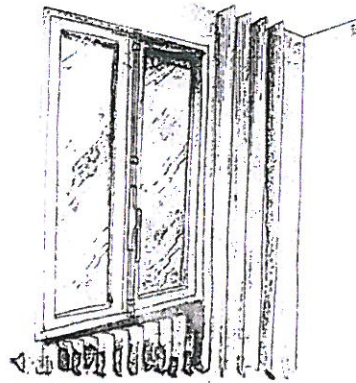
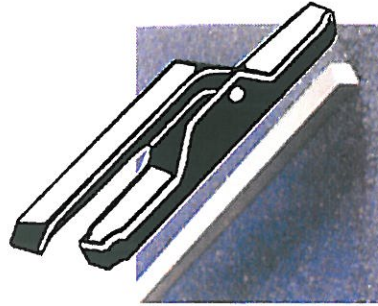

A LEVIER

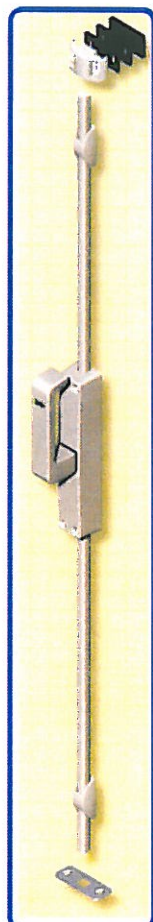
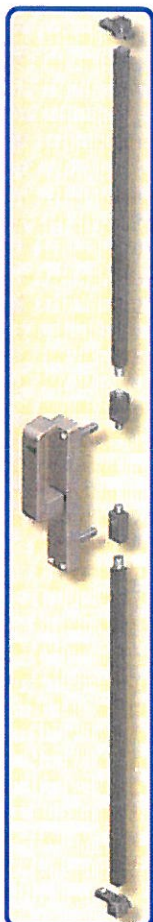

## CREMONES " POMPIER "

VOIR

B 4-4 page7