

B 2.3 ARRET DE VOILETS ACIER

PAGE 1

Vrac

REF

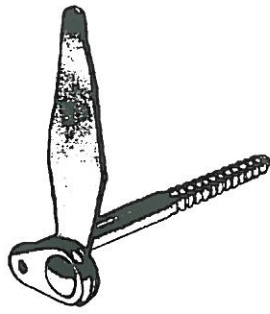

*Cheville S 16 Réf. 21.16
Doir programme
B 11 page 4*

ARRET MARSEILLAIS

A vis tirefond

Noir époxy - 110 mm	61.1	50
95 mm	61.3	50
Blanc époxy/ Zinguée 100%	61.8	20
95 mm	61.35	50
Bichromaté - 110 mm	61.37	50
95 mm	61.36	50
Bichromaté à sceller 140 mm	P 31	50

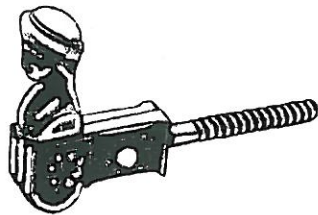

TETE BERGERE ACIER A VIS 70 mm

Bichromatée	61.4	25
Epoxy noir	61.17	25

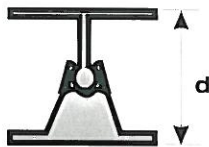

ARRET A RESSORT

Zamack

Chromé - d = 35 mm	61.9	50
Laitonné - d = 35 mm	61.30	50
Noir - 1301TN	61.135	10
Sachet de 2 - Noir - 1301TN	61.135 S	1

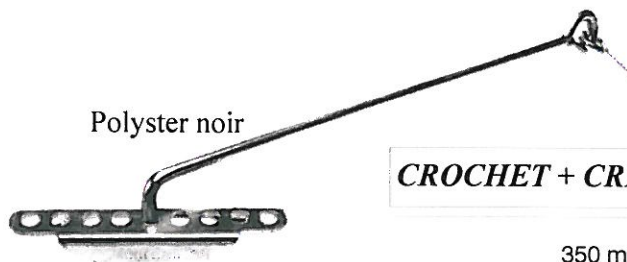
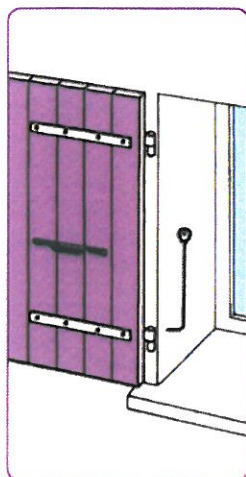

Polyster noir

CROCHET + CREMAILLIERE A POIGNEE

350 mm	61.38	
--------	-------	--

Vrac

REF

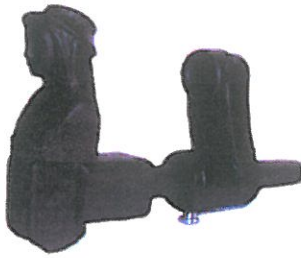

TETE BERGERE ACIER POLYAMIDE 140 mm AVEC BUTEE

Blanc	61.56	25
Noir	61.55	25

ARRET AUTOMATIQUE ALUMINIUM AVEC BUTEE

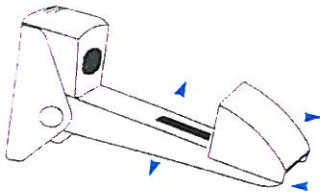
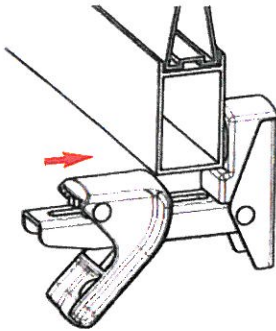

	REF		
	Avec vis + cheville	Sans vis	
Blanc N°1 Réglable de 5 / 50 mm	61.33	61.59	50
Blanc N°2 Réglable de 60 / 105 mm	61.34	61.60	
Noir N° 1 Réglable de 5 à 50 mm	61.18	61.65	
Noir N° 2 Réglable de 60 à 105 mm		61.66	
Blanc ancien modèle N°1 Pratique pour porte fenêtre	61.50		

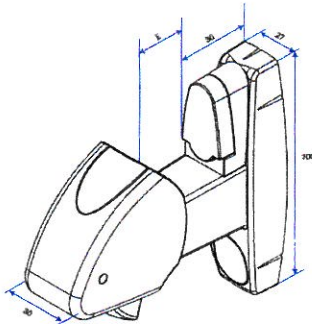

REF

ARRET AUTOMATIQUE POLYAMIDE

Réglable de 5 à 40 mm. (sans la visserie)

Blanc 9016	61.63	Promo net 3,90 €
------------	-------	-----------------------------

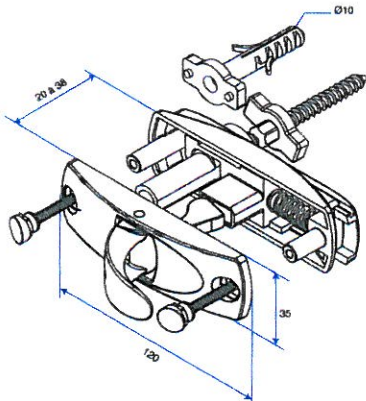

ARRET AUTOMATIQUE STOP BOX

Composite Blanc	61.64	Promo net 5,90 €	30
-----------------	-------	-----------------------------	----



Nouveau produit

Prix de lancement

Vrac

REF

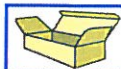

ESPAGNOLETTE RUSTIQUE NOIRE

Sachet accessoires -
Embouts amovibles, 4
colliers cavaliers, 1 support
simple, 2 butées amovibles E

61.58

25

Tube rainuré rond - 1.60 m

61.20

10

Tube rainuré rond - 2.40 m

61.21

10

B : Butée tirefond droite

61.16

10

C : Butée tirefond coudée

61.29

10

D : Collier supplémentaire

61.2

E : Butée coudée à visser

61.31

Butée si
commande
séparée

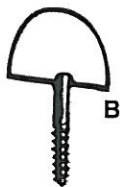
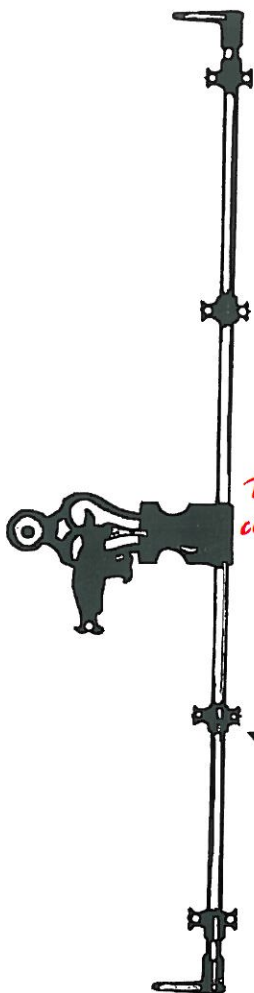

Pour volet 1 vantail

OPTION A - Cavalier déporté

61.22

10

POIGNEE DE VOLET

Epoxy noir

Diam. 8 x Long : 160mm

61.19

10

POIGNEE St ETIENNE

Acier zingué

140 mm - int. poignée 60

52.5

25

160 mm - int. poignée 76

52.7

25

POIGNEE

100 mm - Bichromatée

52.6

20

Creuse zinguée

113.9

20

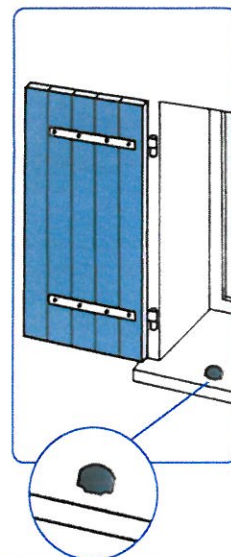
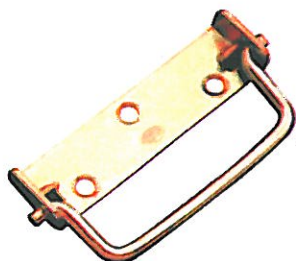

En partie haute,
utiliser les dardennes
ou butées coudées
afin d'éviter
l'éclatement du linteau.

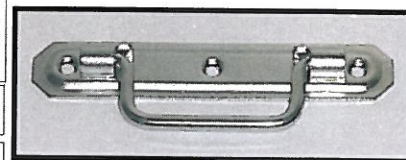

Vrac

Conditionné

REF

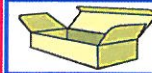

REF

Bte

CROCHETS LAITONNES

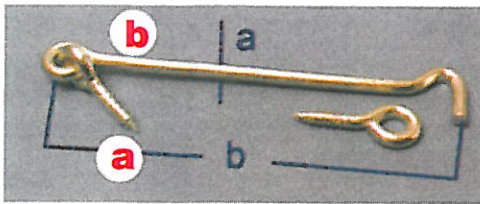

a - Fil	b - Longueur		Sachet 1
3.3	50 mm	611.2	10
3.9	80 mm	611.3	10
4.2	120 mm	611.5	10
5	160 mm	611.6	10

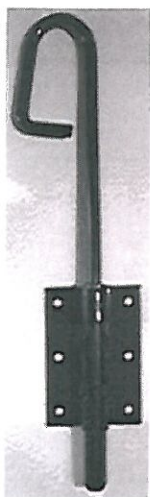

VERROUS BAÏONETTE NOIR

14 x 300 mm			611.05	6
14 x 500 mm			611.06	6

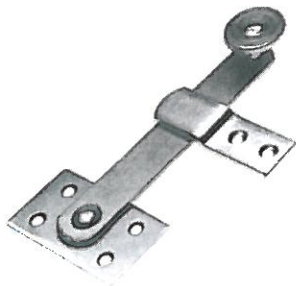

TAQUET BASCULANT (ou fléau persienne)

Long. 160 mm - Bichromaté

61.128

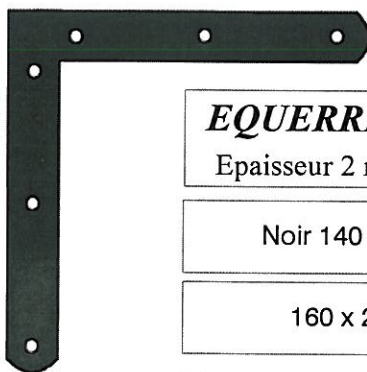
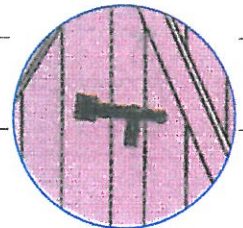

EQUERRE DE FENETRE

Epaisseur 2 mm - Bouts ronds

Noir 140 x 20 mm	61.7	25
160 x 24 mm	61.10	25
Bichromaté 140 x 20 mm	61.5	25
160 x 24 mm	61.6	25

